

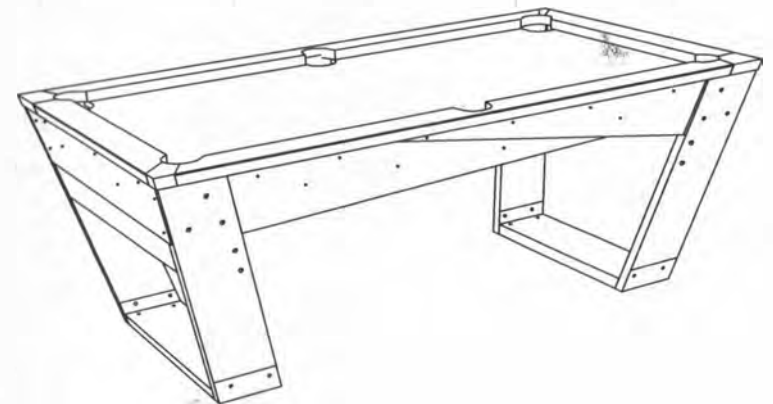











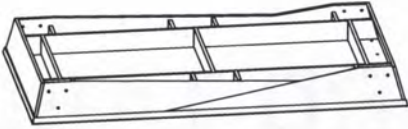

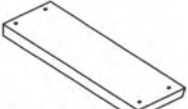

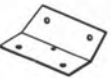
BILLIARD TABLE

ASSEMBLY INSTRUCTIONS









7FT SCORPION



PARTS LIST

<p>P1</p>  <p>POOL TABLE 1set</p>	<p>P2</p>  <p>Leg A 2pcs</p>
<p>P4</p>  <p>Leg panel A 2pcs</p>	<p>P3</p>  <p>Leg B 2pcs</p>
<p>H2</p>  <p>Angle iron B 2pcs</p>	<p>P5</p>  <p>Leg panel B 2pcs</p>
<p>H5</p>  <p>Leg leveler 4pcs</p>	<p>H1</p>  <p>Angle iron A 2pcs</p>
<p>H8</p>  <p>5/16" Nut 16pcs</p>	<p>H3</p>  <p>Angle iron C 2pcs</p>
<p>H9</p>  <p>5/16" * 1-1/2" Bolt 12pcs</p>	<p>H4</p>  <p>Angle iron D 2pcs</p>
<p>H7</p>  <p>5/16" * 2" Bolt 16pcs</p>	<p>H10</p>  <p>1/4" Washer 8pcs</p>

PARTS LIST

<p>H11</p>  <p>1/4" * 2-1/2" Bolt 8pcs</p>	<p>H12</p>  <p>Cross Dowel 8pcs</p>	<p>H13</p>  <p>5/16" Allen key 2pcs</p>
<p>H14</p>  <p>1/4" Allen key 1pc</p>	<p>#1</p>  <p>Billiard ball 1set</p>	<p>#2</p>  <p>Triangle rack 1pc</p>
<p>#3</p>  <p>Brush 1pc</p>	<p>#4</p>  <p>Cue stick 2pcs</p>	<p>#5</p>  <p>Chalk 2pcs</p>

Assembly steps

WARNING: TWO ADULTS NEEDED TO ASSEMBLE POOL TABLE

1. Lay the box on a flat surface (The floor).
You may want this near your area of assembly.
2. Unpack the boxes and the parts bag to inspect and count the parts.
The parts identifier page can be used to record your results.

STEP 1

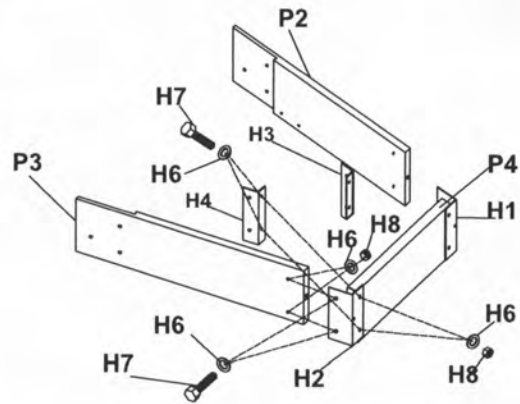

STEP 2

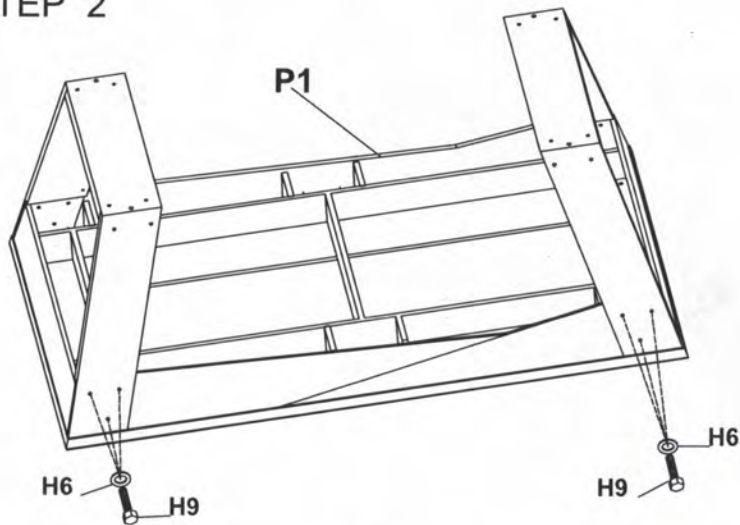

Assembly steps

WARNING: TWO ADULTS NEEDED TO ASSEMBLE POOL TABLE

STEP 3

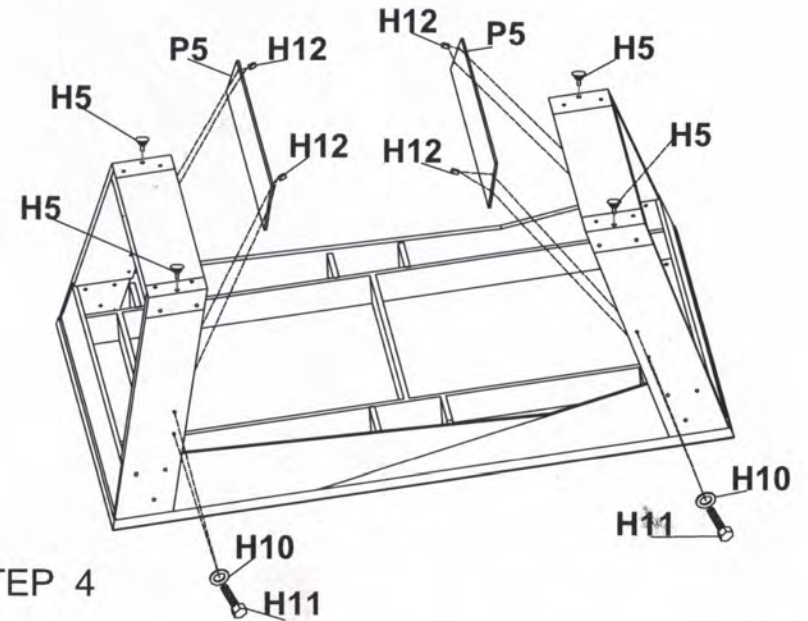

STEP 4

