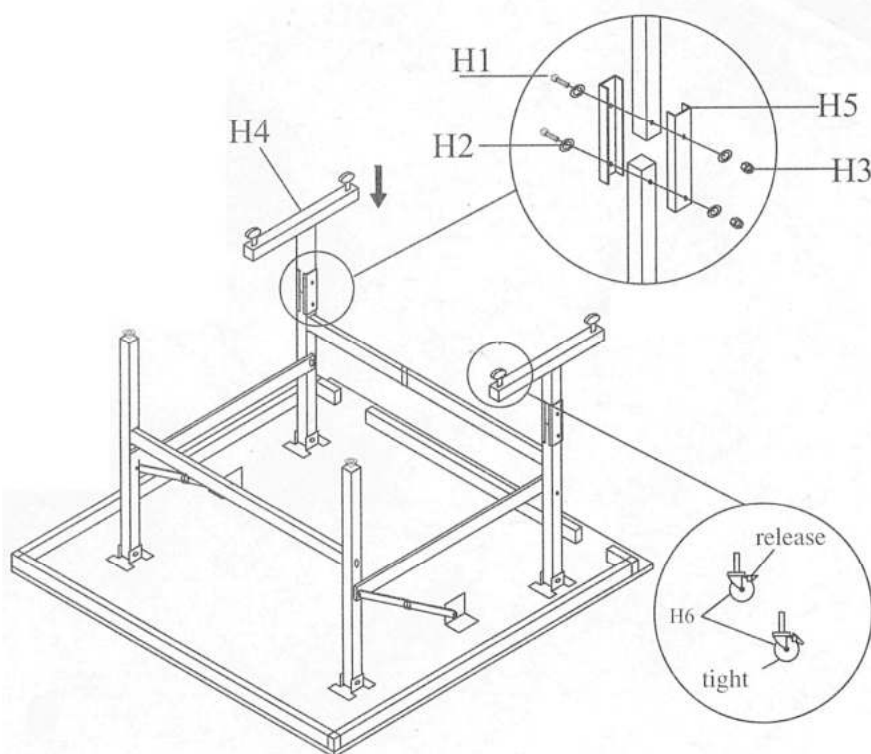

TABLE TENNIS – ANDRE



ASSEMBLY INSTRUCTIONS

1. The packing can be divided into two parts. One packing is for table, two groups of H type undercarriages & two pieces of connecting shafts for the purpose of joining two supporting frames. Another packing is for four groups of T type supporting frame assembled with wheels.
2. DIRECTION OF INSTALLATION:
 - a. Owing to the situation that the table is heavy, person for installing or moving table should be two or more.
 - b. After open the carton, please reverse the table and put down on the carton put on the ground.
 - c. Please take out two pieces of connecting shafts and release the bolts on both ends of the shaft







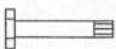

WARNING:

Two adults needed to assemble table.

PARTS IDENTIFIER

HARDWARE

sketch	Index name	spec	quantity
	H1	bolt M8	8
	H2	washer Ø8	16
	H3	nut M8	8
	H4	T type leg	4
	H5	caster	8
	H6	wheel	8